

La técnica del confort

TÉCNICAS DE TAPICERÍA TAPITEC, S.L.



**tapitec**®  
TÉCNICAS DE TAPICERÍA TAPITEC, S.L.

Polígono Industrial "EL PLA" · Camí del Clot nº 2 · Telf: 962 828 017 FAX: 962 837 353  
46760 - TAVERNES DE LA VALLDIGNA - Apto. Correos 166 · e-mail: [ventas@tapitec.eu](mailto:ventas@tapitec.eu)  
Valencia - España

Modelos 2020

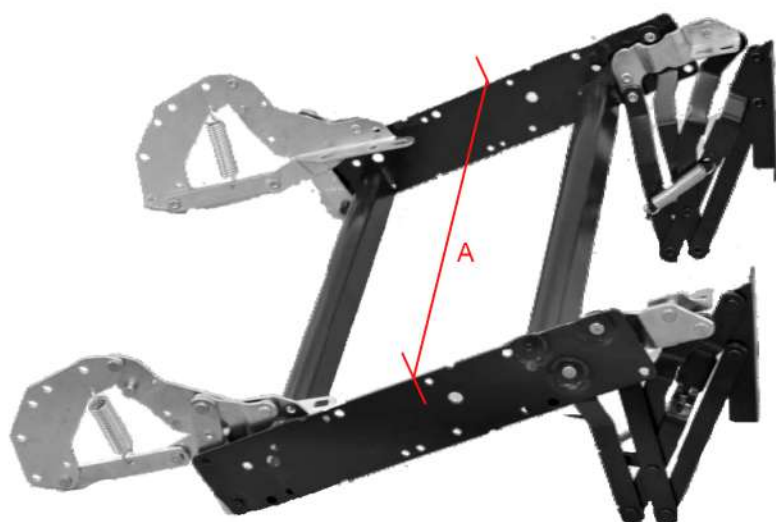

mecánica + cuña respaldo

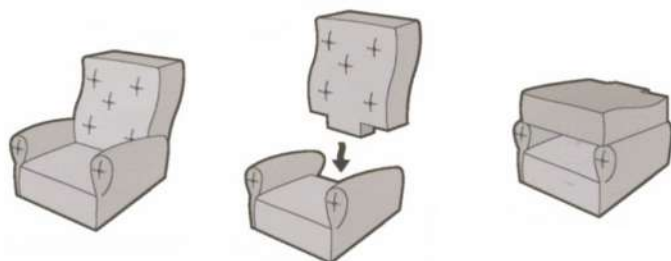

Montaje

Transporte y almacén

MODELO: B + SILLÓN RELAX MANUAL + CUÑA RESPALDO		ANCHO A	UNDS. X PALET
COD.	DESCRIPCIÓN		
022201	B02 SILLÓN RELAX 520 + CUÑA ASIENTO	520 mm.	140
022210	B02 SILLÓN RELAX 570 + CUÑA ASIENTO	570 mm.	140

MODELO: B / SILLÓN RELAX MANUAL		ANCHO A	UNDS. X PALET
COD.	DESCRIPCIÓN		
021200	B01 SILLÓN RELAX / 520 mm.	520 mm.	140
021700	B01 SILLÓN RELAX / 570 mm.	570 mm.	140
025200	B11 SILLÓN RELAX / 520 mm.	520 mm.	160
025700	B11 SILLÓN RELAX / 570 mm.	570 mm.	160
022200	B02 SILLÓN RELAX / 520 mm.	520 mm.	140
022700	B02 SILLÓN RELAX / 570 mm.	570 mm.	140
026200	B22 SILLÓN RELAX / 520 mm.	520 mm.	140
026700	B22 SILLÓN RELAX / 570 mm.	570 mm.	140

mecánica + asiento



MODELO: B + ASIENTO / SILLÓN RELAX MANUAL + ASIENTO MUELLES		ANCHO A	UNDS. X PALET
COD.	DESCRIPCIÓN		
021210	B01 SILLÓN RELAX + ASIENTO	520 mm.	140
022210	B02 SILLÓN RELAX + ASIENTO	520 mm.	140

## Accesorios Opcionales

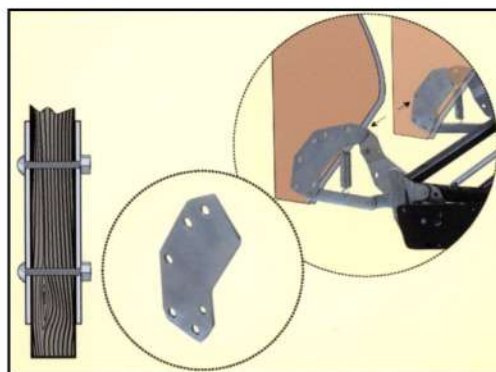

MODELO: B / REFUERZO RESPALDO SILLÓN RELAX S/B		UNDS. X PALET
COD.	DESCRIPCIÓN	
117810	REFUERZO RESPALDO SILLÓN RELAX SB	2048





MANDO ENCASTRE



MANDO PERIFÉRICO

MODELO: B2M / SILLÓN RELAX MOTORIZADO		ANCHO	UNDS.
COD.	DESCRIPCIÓN	A	X PALET
064010	B2M SILLÓN RELAX MOTOR - MANDO ENCASTRE	520 mm.	25
064020	B2M SILLÓN RELAX MOTOR - MANDO PERIFÉRICO	520 mm.	25



MANDO ENCASTRE



MANDO PERIFÉRICO

MODELO: B2 SILLÓN RELAX AYUDA LEVANTAR MOTOR		ANCHO	UNDS.
COD.	DESCRIPCIÓN	A	X PALET
071010	SILLÓN AYUDA LEVANTAR MOTOR MANDO ENCASTRE	520 mm.	17
071020	SILLÓN AYUDA LEVANTAR MOTOR MANDO PERIFÉRICO	520 mm.	17



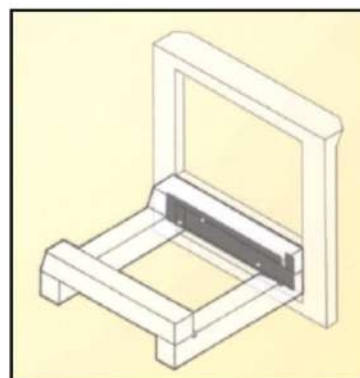

MODELO: D / SILLÓN RELAX 2 POSICIONES		UNDS.
COD.	DESCRIPCIÓN	X PALET
040000	D / SILLÓN RELAX	12/180

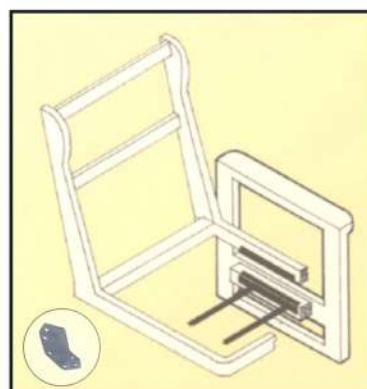

MODELO: D.T. / SILLÓN RELAX 2 POSICIONES CON TRAVESEROS		ANCHO	UNDS.
COD.	DESCRIPCIÓN	A	X PALET
046460	D.T. SILLÓN RELAX D/2 POS. + TRAVESEROS	460 mm.	50
046480	D.T. SILLÓN RELAX D/2 POS. + TRAVESEROS	480 mm.	50





## Bases desmontables 1-2 y 3 plazas

MODELO: DPT - SILLÓN RELAX 2 POSICIONES + BASE		ANCHO	UNDS.
COD.	DESCRIPCIÓN	A	X PALET
043250	DPT - SILLÓN RELAX + BASE D/520 - 50	520 mm.	12/90
043545	DPT - SILLÓN RELAX + BASE D/550 - 45	550 mm.	12/90
043750	DPT - SILLÓN RELAX + BASE D/570 - 50	570 mm.	12/90



MODELO: DPT - SILLÓN RELAX 2 POSICIONES TRESILLOS		ANCHO	UNDS.
COD.	DESCRIPCIÓN	A	X PALET
044920	DPT - SILLÓN RELAX 2 POS. TRESILLO 2 PLAZAS	1080 mm.	12/100
044930	DPT - SILLÓN RELAX 2 POS. TRESILLO 3 PLAZAS	1600 mm.	12/100

## Accesorios de anclaje

### Soporte desmontable

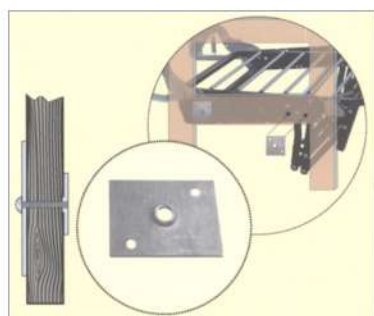
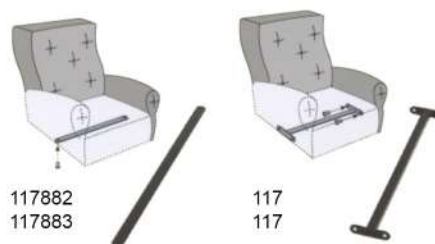
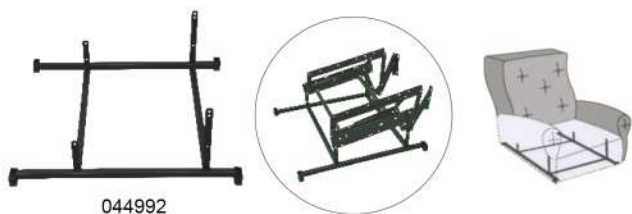

MODELO:	ACCESORIOS REFUERZO	ANCHO	UNDS.
COD.	DESCRIPCIÓN	A	X PALET
044992	SOPORTE PIES TIERRA RELAX D/520 mm.	520 mm.	50
044997	SOPORTE PIES TIERRA RELAX D/570 mm.	570 mm.	50
117882	BARRA RELAX D SOPORTE 630 mm.	630 mm.	200
117883	BARRA RELAX D SOPORTE 678 mm.	678 mm.	200
117810	REFUERZO UNIÓN RESPALDO RELAX D		2048
117	REFUERZO BRAZOS T/485 CON PLATINAS	485 mm.	500
117	REFUERZO BRAZOS T/525 CON PLATINAS	525 mm.	500

Refuerzos fijación brazos 117822 R.M. - 10

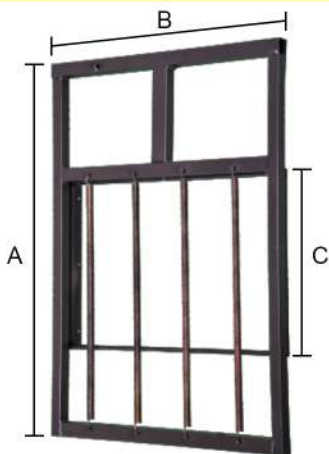

MODELO: ASIENTO EXTRAIBLE CON MUELLES PINTADO NEGRO		ASIENTO (mm.)		BASE (mm.)
COD.	DESCRIPCIÓN	A	B	C
302621	Asiento Extraible con Muelle 650 x 720 BA - 350	650	720	350
304801	Asiento Extraible con Muelle 820 x 465 BA - 380	820	465	380
304821	Asiento Extraible con Muelle 820 x 720 BA - 380	820	720	380

MODELO: ASIENTO EXTRAIBLE CON CINCHA PINTADO NEGRO		ASIENTO (mm.)		BASE (mm.)
COD.	DESCRIPCIÓN	A	B	C
310484	Asiento Extraible con Cincha 820 x 540 B - 380	820	540	380
310486	Asiento Extraible con Cincha 820 x 650 B - 380	820	650	380
310752	Asiento Extraible con Cincha 750 x 520 B - 380	750	520	380
310770	Asiento Extraible con Cincha 750 x 700 B - 380	750	700	380

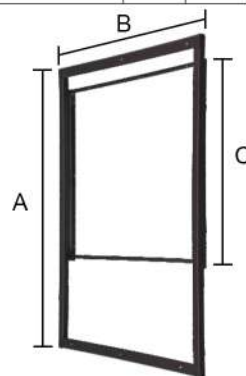
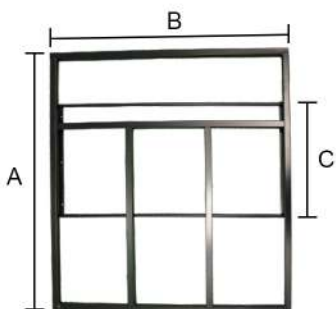

MODELO: ASIENTO EXTRAIBLE CON BARRAS PINTADO NEGRO		ASIENTO (mm.)		BASE (mm.)
COD.	DESCRIPCIÓN	A	B	C
343808	Asiento Extraible con Barras 800 x 580 BA - 360	800	580	360
343823	Asiento Extraible con Barras 800 x 730 BA - 360	800	730	360

MODELO: ASIENTO EXTRAIBLE SIN MUELLES PINTADO NEGRO		ASIENTO (mm.)		BASE (mm.)
COD.	DESCRIPCIÓN	A	B	C
323705	Asiento Extraible sin Muelles 700 x 550 BA - 360	700	550	360
323725	Asiento Extraible sin Muelles 700 x 750 BA - 360	700	750	360
325802	Asiento Extraible sin Muelles 800 x 525 BA - 430	800	525	430
325823	Asiento Extraible sin Muelles 800 x 730 BA - 430	800	730	430

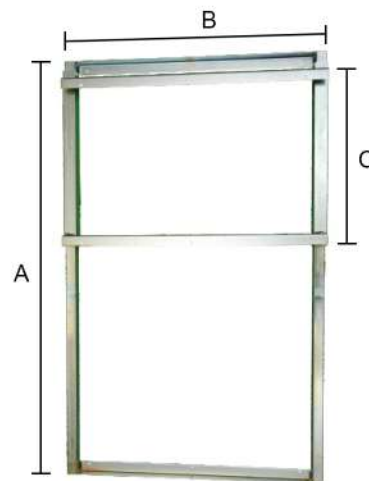
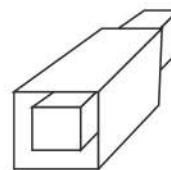

MODELO: ASIENTO EXTRAIBLE SIN MUELLES Y SIN PINTAR		ASIENTO (mm.)		BASE (mm.)
COD.	DESCRIPCIÓN	A	B	C
361800	Asiento Extraible sin Muelles 810 x 500 BA - 340	810	500	340
361804	Asiento Extraible sin Muelles 810 x 540 BA - 340	810	540	340
361822	Asiento Extraible sin Muelles 810 x 725 BA - 340	810	725	340
366800	Asiento Extraible sin Muelles 810 x 500 BA - 450	810	500	450
366804	Asiento Extraible sin Muelles 810 x 540 BA - 450	810	540	450
366815	Asiento Extraible sin Muelles 810 x 650 BA - 450	810	650	450
366824	Asiento Extraible sin Muelles 810 x 740 BA - 450	810	740	450

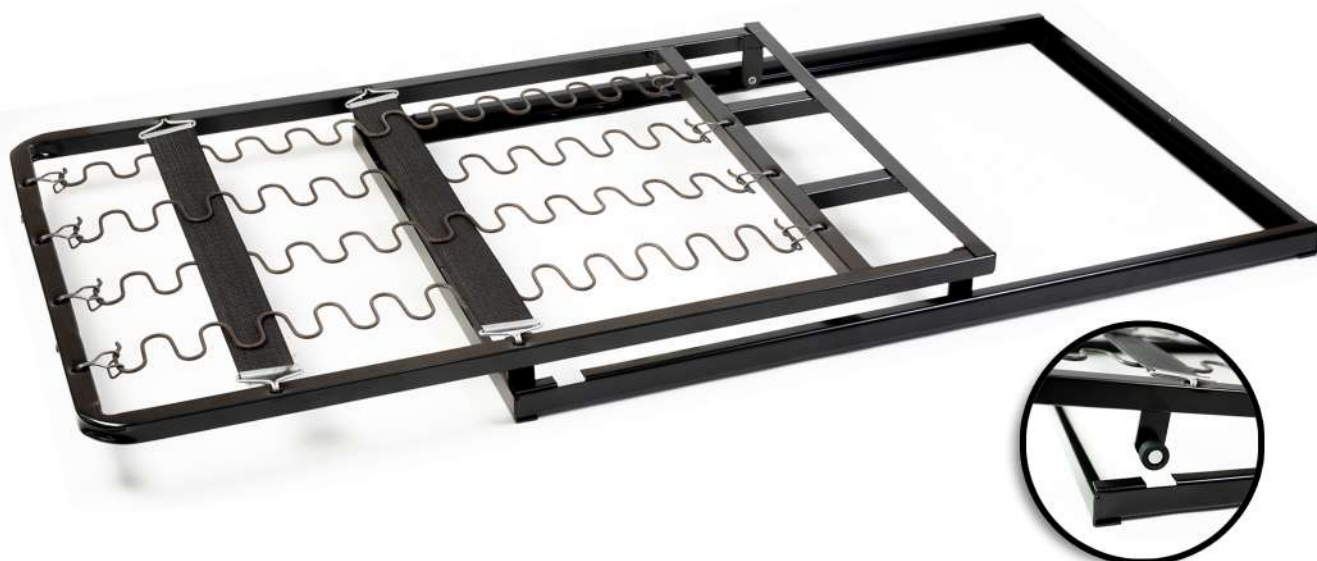

MODELO: 40 - EXTRAIBLE CON RUEDAS PINTADO NEGRO		ASIENTO (mm.)				BASE (mm.)		UNDS. x PALET
COD.	DESCRIPCIÓN	A	B	C	D	X	Y	
401752	Ext. C/Rda. + Mue. + 2 Cincha 780 x 520 mm.	780	520	340	70	780	520	100
401760	Ext. C/Rda. + Mue. + 2 Cincha 780 x 600 mm.	780	600	340	70	780	600	100
401770	Ext. C/Rda. + Mue. + 2 Cincha 780 x 700 mm.	780	700	340	70	780	700	100



MODELO: 37 - EXTRAIBLE CON RUEDAS PINTADO NEGRO		ASIENTO (mm.)				BASE (mm.)		UNDS. x PALET
COD.	DESCRIPCIÓN	A	B	C	D	X	Y	
371752	Ext. C/Rda. + Cincha. 780 x 520 mm.	780	520	340	70	780	520	200
371760	Ext. C/Rda. + Cincha. 780 x 600 mm.	780	600	340	70	780	600	200
371770	Ext. C/Rda. + Cincha. 780 x 700 mm.	780	700	340	70	780	700	200

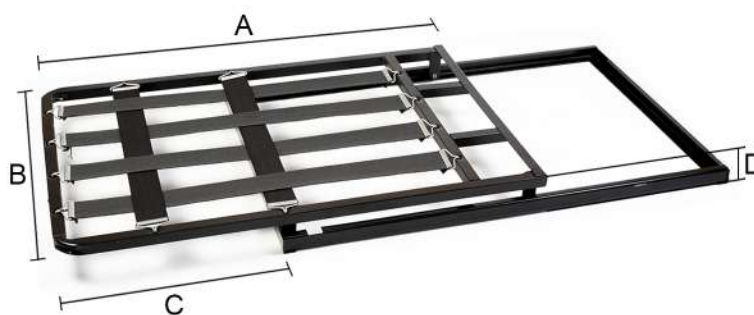



MODELO: 42 - EXTRAIBLE CON RUEDAS PINTADO NEGRO		ASIENTO (mm.)				BASE (mm.)		UNDS. x PALET
COD.	DESCRIPCIÓN	A	B	C	D	X	Y	
426852	Ext. C/Rda. + 2 Cincha 780 x 520 x 735 mm.	780	520	340	70	735	520	100
426860	Ext. C/Rda. + 2 Cincha 780 x 600 x 735 mm.	780	600	340	70	735	600	100
426870	Ext. C/Rda. + 2 Cincha 780 x 700 x 735 mm.	780	700	340	70	735	700	100

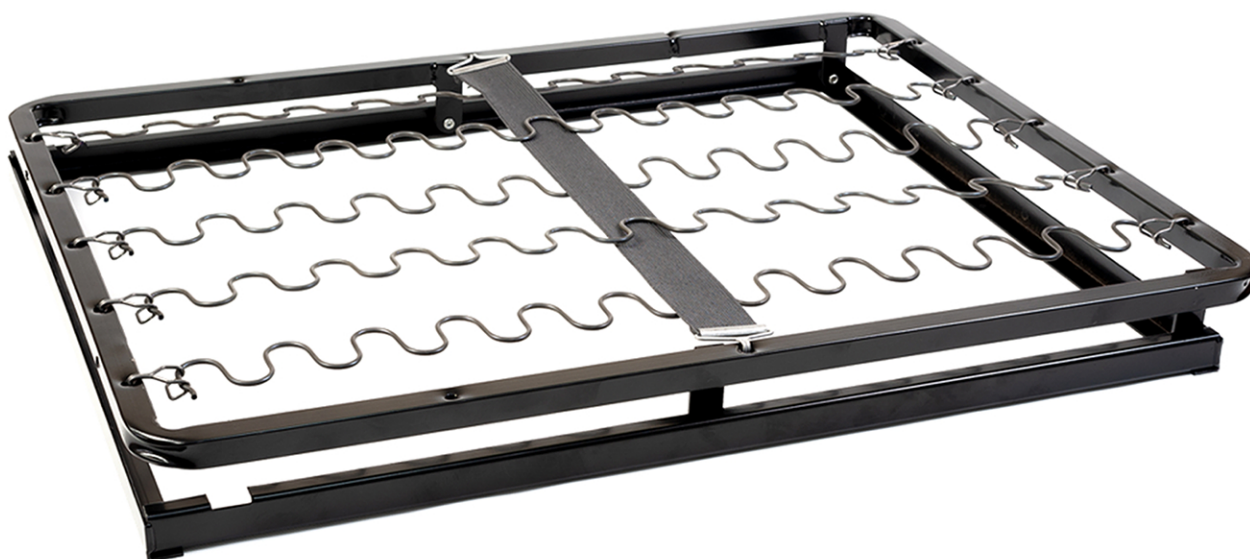

MODELO: 43 - EXTRAIBLE CON RUEDAS PINTADO NEGRO		ASIENTO (mm.)				BASE (mm.)		UNDS. x PALET
COD.	DESCRIPCIÓN	A	B	C	D	X	Y	
436852	Ext. C/Rda. + Mue. + Cincha 780 x 520 x 735 mm.	780	520	340	70	735	520	100
436860	Ext. C/Rda. + Mue. + Cincha 780 x 600 x 735 mm.	780	600	340	70	735	600	100
436870	Ext. C/Rda. + Mue. + Cincha 780 x 700 x 735 mm.	780	700	340	70	735	700	100

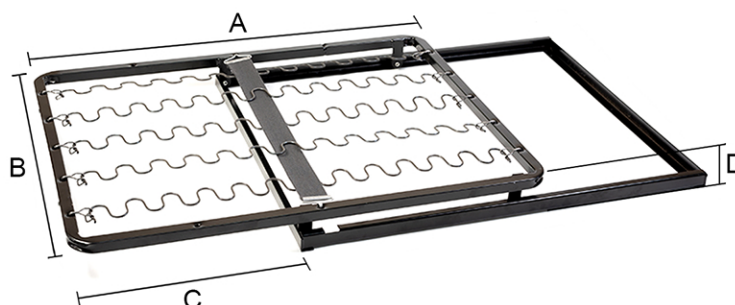
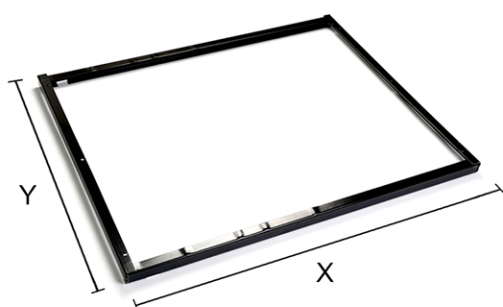





MODELO: 426 - EXTRAIBLE CON RUEDAS PINTADO NEGRO		ASIENTO (mm.)				BASE (mm.)		UNDS. x PALET
COD.	DESCRIPCIÓN	A	B	C	D	X	Y	
426751	Ext. C/Rda. + Cincha 750 x 495 x 660 mm.	750	495	135	70	660	495	200
426756	Ext. C/Rda. + Cincha 750 x 545 x 660 mm.	750	545	135	70	660	545	200
426761	Ext. C/Rda. + Cincha 750 x 595 x 660 mm.	750	595	135	70	660	595	200
426770	Ext. C/Rda. + Cincha 750 x 695 x 660 mm.	750	695	135	70	660	695	200

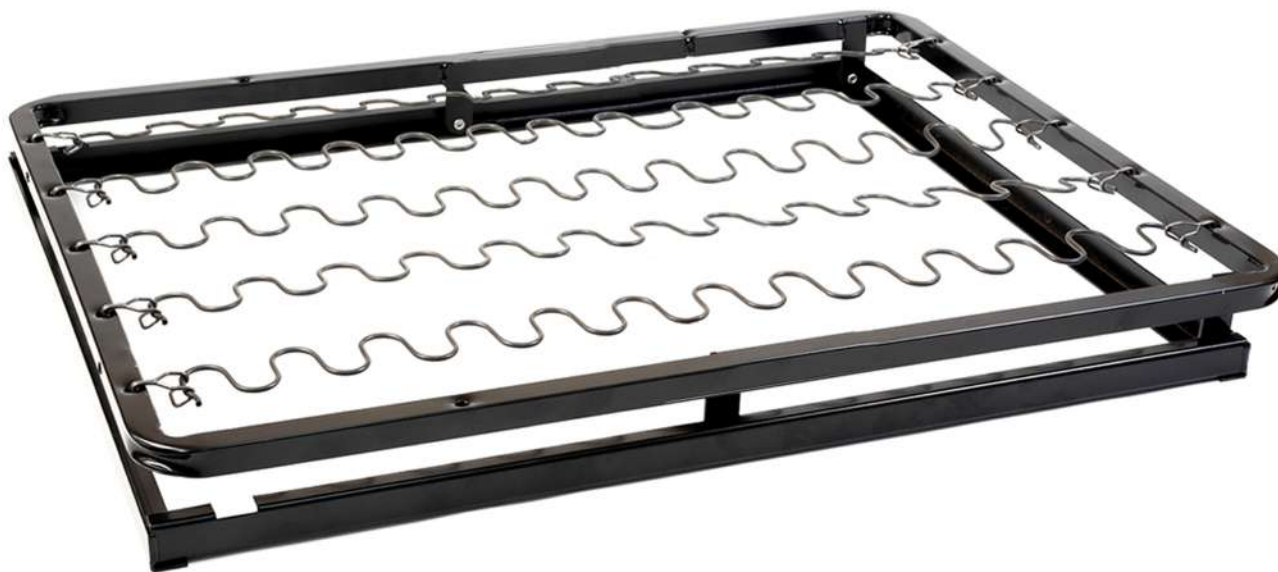

MODELO: 429 - EXTRAIBLE CON RUEDAS PINTADO NEGRO		ASIENTO (mm.)				BASE (mm.)		UNDS. x PALET
COD.	DESCRIPCIÓN	A	B	C	D	X	Y	
429975	Ext. C/Rda. + Mue. 750 x 495 x 660 mm.	750	495	135	70	660	495	200
429976	Ext. C/Rda. + Mue. 750 x 595 x 660 mm.	750	595	135	70	660	595	200
429977	Ext. C/Rda. + Mue. 750 x 695 x 660 mm.	750	695	135	70	660	695	200

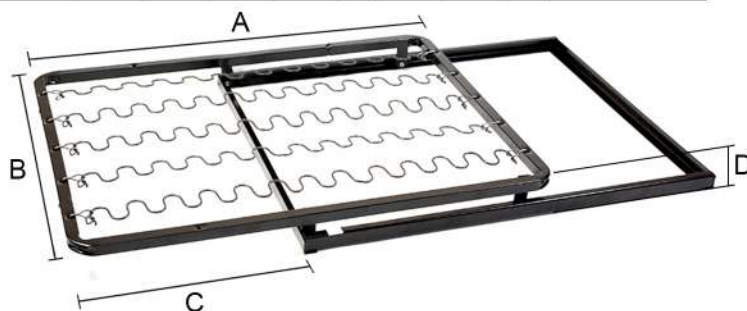

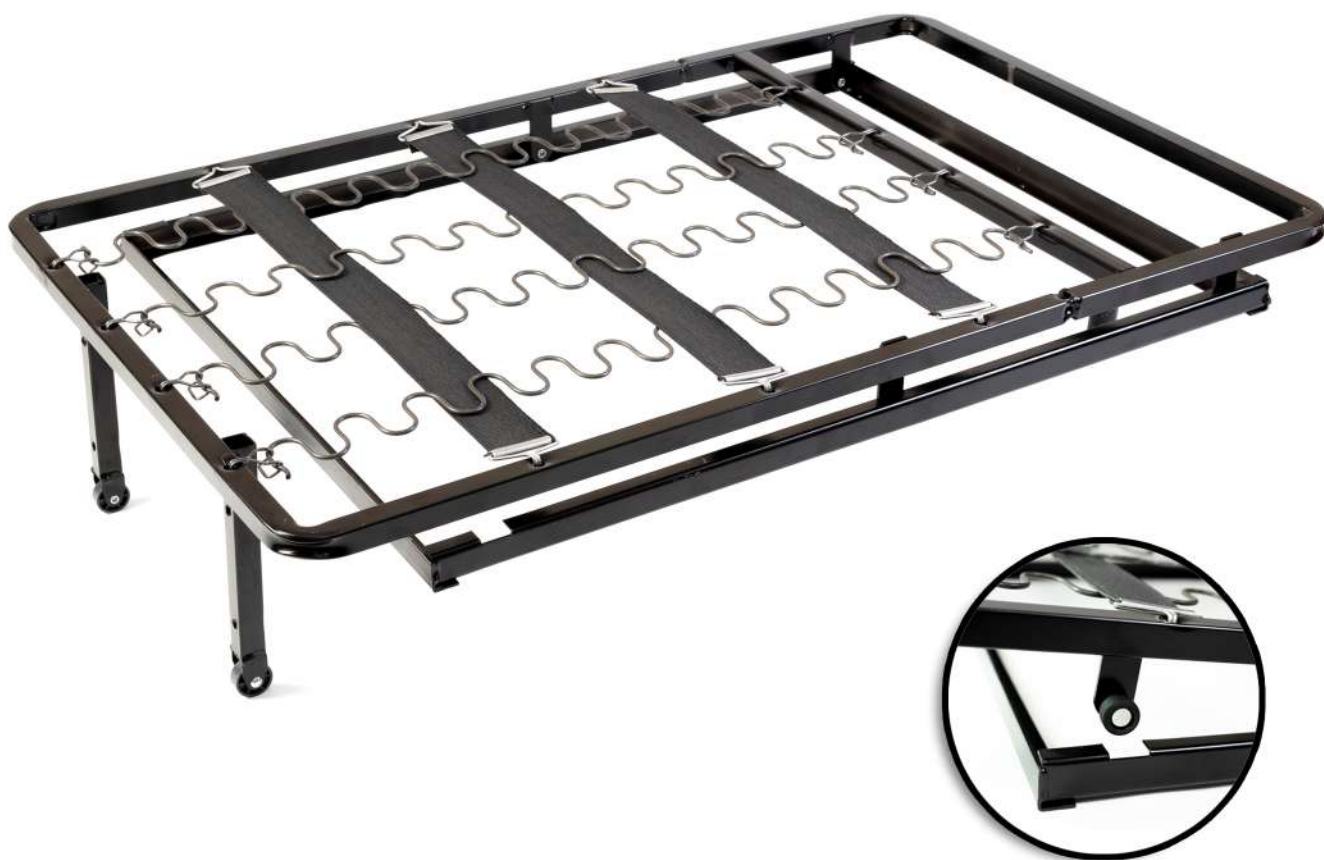

MODELO: 44 - EXTRAIBLE CON RUEDAS Y PATAS PINTADO NEGRO		ASIENTO (mm.)					BASE (mm.)		UNDS. x PALET
COD.	DESCRIPCIÓN	A	B	C	B	E	X	Y	
449952	Ext. C/Rda. + Muelle + Cincha + Patas 970 x 520 x 780 mm.	970	520	495	70	220	780	520	50
449960	Ext. C/Rda. + Muelle + Cincha + Patas 970 x 600 x 780 mm.	970	600	495	70	220	780	600	50
449970	Ext. C/Rda. + Muelle + Cincha + Patas 970 x 700 x 780 mm.	970	700	495	70	220	780	700	50

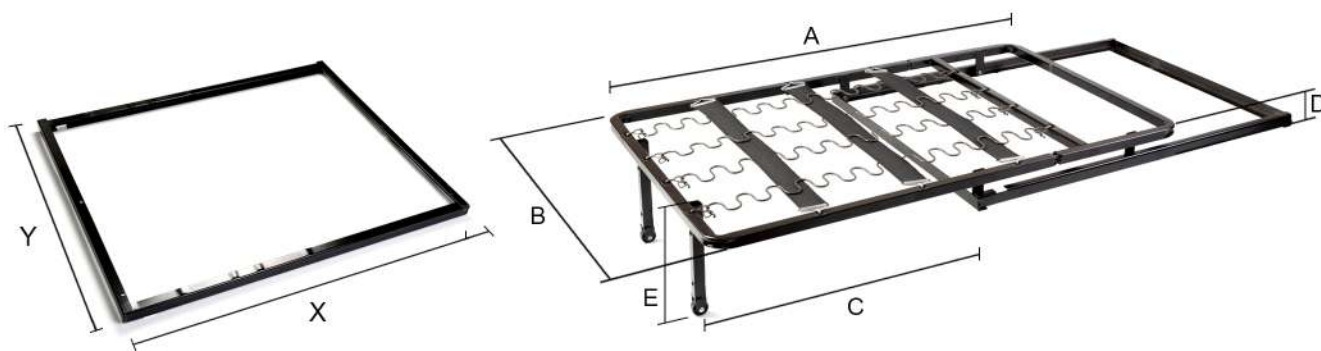



MODELO: 49 - EXTRAIBLE BRAZO PINTADO NEGRO		BASE (mm.)			UNDS. x PALET
COD.	DESCRIPCIÓN	F	G	Z	
490001	Ext. Brazo + Tap. 940 x 150 B 500 mm.	940	150	500	500



MODELO: 16 - RECLINABLE TAPA BRAZO SIN BAÑO		(mm.)	UNDS. x PALET
COD.	DESCRIPCIÓN	H	
160600	Reclinable Brazo PL/2T de 600 mm.	600	200
160650	Reclinable Brazo PL/2T de 650 mm.	650	200
160700	Reclinable Brazo PL/2T de 700 mm.	700	200
160850	Reclinable Brazo PL/2T de 850 mm.	850	200



MODELO: 445 - EXTRAIBLE CON RUEDAS Y SIN ASIENTO PINTADO NEGRO		ASIENTO		BASE		UNDS. x PALET
COD.	DESCRIPCIÓN	A	B	X	Y	
44577525	Ext. S/Asto. 770 x 525 B 500 mm.	480	500	770	525	200
44577625	Ext. S/Asto. 770 x 625 B 500 mm.	580	500	770	625	200



MODELO: 38 - EXTRAIBLE SIMPLE CON TAPÓN S/B		BASE (mm.)		ASIENTO (mm.)	UNDS. x PALET
COD.	DESCRIPCIÓN	A	B	X	
380365	Ext. Simple + Tap. 650 BA 350 mm. S/B	650	80	350	1.000
380377	Ext. Simple + Tap. 775 BA 350 mm. S/B	775	80	350	1.000

MODELO: 38 - EXTRAIBLE SIMPLE CON TAPÓN PINTADO NEGRO		BASE (mm.)		ASIENTO (mm.)	UNDS. x PALET
COD.	DESCRIPCIÓN	A	B	X	
389778	Ext. Simple + Tap. 780 BA 500 mm. Negro	780	80	500	1.000

MODELO: 38 - EXTRAIBLE SIMPLE SIN TAPÓN PINTADO NEGRO		BASE (mm.)		ASIENTO (mm.)	UNDS. x PALET
COD.	DESCRIPCIÓN	A	B	X	
385780	Ext. Simple 780 BA 400 mm. Negro	780	80	400	1.000



MODELO: 41 - EXTRAIBLE PAR SIMPLE CON RUEDAS PINTADO NEGRO		BASE (mm.)		ASIENTO (mm.)	UNDS. x PALET
COD.	DESCRIPCIÓN	A	B	X	
417843	Ext. Par Simple + Rda. 765 x 430 mm.	765	125	430	500
417850	Ext. Par Simple + Rda. 765 x 500 mm.	765	125	500	500
417873	Ext. Par Simple + Rda. 765 x 730 mm.	765	125	730	500
4191050	Ext. Par Simple + Rda. 1020 x 500 mm.	1020	125	500	500



MODELO: CARRACAS CABEZALES		UNDS.
COD.	DESCRIPCIÓN	X PALET
116701	Carraca nº 6 - 1 Arandela Cincada	400 / 8000

MODELO: CARRACAS CABEZALES		UNDS.
COD.	DESCRIPCIÓN	X PALET
116725	Carraca nº 6 - 1 Pala larga S/B - Cin.	400 / 8000



MODELO: SOPORTES CARRACAS		UNDS.
COD.	DESCRIPCIÓN	X PALET
116640	Soporte Carraca Serie D - S/B	400 / 8000



MODELO: SOPORTES CARRACAS		UNDS.
COD.	DESCRIPCIÓN	X PALET
116682	Plástico Soporte Carracas	400 / 8000



MODELO: SOPORTES CARRACAS		UNDS.
COD.	DESCRIPCIÓN	X PALET
116631	Soporte Carraca Serie C - Cincada	400 / 8000
116630	Soporte Carraca Serie C - S/B	400 / 8000

## Patas Redondas Sillón

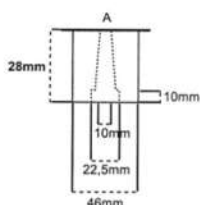

MODELO: PATAS REDONDAS		UNDS.
COD.	DESCRIPCIÓN	
100132	Patas Redondas 28 mm.	800

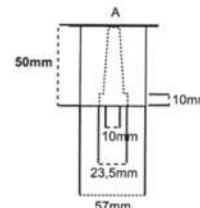

MODELO: PATAS REDONDAS		UNDS.
COD.	DESCRIPCIÓN	
100152	Patas Redondas 50 mm.	250

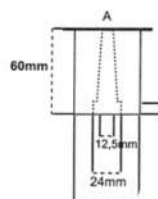

MODELO: PATAS REDONDAS		UNDS.
COD.	DESCRIPCIÓN	
100162	Patas Redondas 60 mm.	200



MODELO: CABEZAL BASCULANTE		(mm.)			UNDS. x PALET
COD.	DESCRIPCIÓN	A	B	C	
198440	Cabezal Multimedida 440 / 880 mm. S/B	Ancho	320	115	400

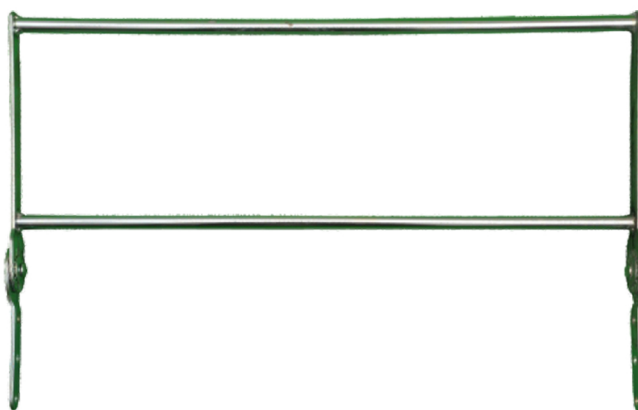

MODELO: CABEZAL BASCULANTE		(mm.)			UNDS. x PALET
COD.	DESCRIPCIÓN	A	B	C	
193430	Cabezal P.L. - 2 Tubos 430 mm. S/B	430	320	115	400
193500	Cabezal P.L. - 2 Tubos 500 mm. S/B	500	320	115	400
193550	Cabezal P.L. - 2 Tubos 550 mm. S/B	550	320	115	400
193600	Cabezal P.L. - 2 Tubos 600 mm. S/B	600	320	115	400
193695	Cabezal P.L. - 2 Tubos 695 mm. S/B	695	320	115	400

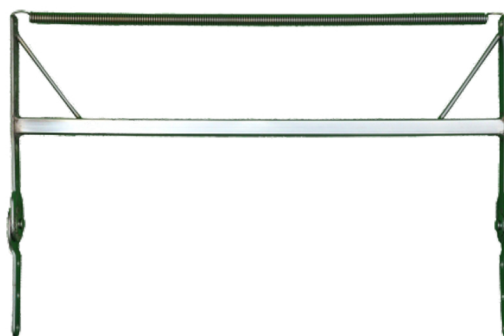
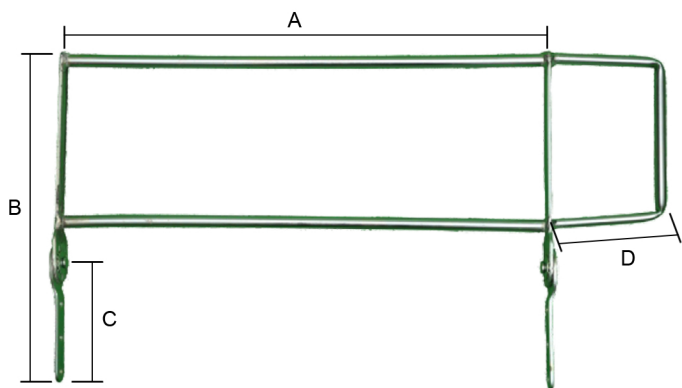

MODELO: CABEZAL BASCULANTE		(mm.)				UNDS. x PALET
COD.	DESCRIPCIÓN	A	B	C	D	
194743	Cabezal P.L. / 2 T. + Oreja 430 mm. S/B	430	320	115	150	400
194855	Cabezal P.L. / 2 T. + Oreja 550 mm. S/B	550	320	115	250	400

MODELO: CABEZAL BASCULANTE		(mm.)			UNDS. x PALET
COD.	DESCRIPCIÓN	A	B	C	
195480	Cabezal P.L. + Muelle 480 mm. S/B	480	320	115	400
195680	Cabezal P.L. + Muelle 680 mm. S/B	680	320	115	400



MODELO:	BISAGRAS 2 POSICIONES SOFÁ LIBRO	UNDS.
COD.	DESCRIPCIÓN	X PALET
460013	Par Bisagra Modelo D-CF + Muelle Pintada	10 / 200

\* Se acciona desde el respaldo



MODELO:	BISAGRAS 3 POSICIONES SOFÁ LIBRO	UNDS.
COD.	DESCRIPCIÓN	X PALET
461401	Par Bisagra nº 4 Cincada	10 / 400

\* Se acciona desde el asiento

### MUY IMPORTANTE:

Cuando el asiento del sofá-libro está en la posición (A) del funcionamiento del mecanismo, se deberá presionar el colchón o espuma lo necesario para que se accione el gatillo.

Si no se actúa así, no se activará la bisagra y por lo tanto existe el PELIGRO de roturas.

En caso de dudas, consulte nuestro Servicio Técnico.

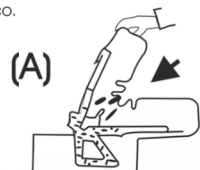

### MUY IMPORTANTE:

La distancia (A) mínima entre hojas recomendada es aproximadamente de:

100mm para colchonetas de espuma  
120mm para colchonetas de muelles

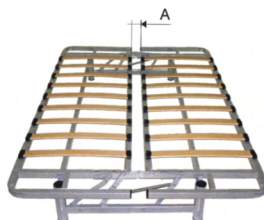

MODELO:	BISAGRAS 2 POSICIONES SOFÁ LIBRO	UNDS.
COD.	DESCRIPCIÓN	X PALET
462000	Par Bisagra BL - UNA - P - S/B	10 / 320

\* Se acciona desde el asiento

## Balancines

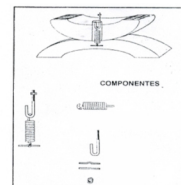
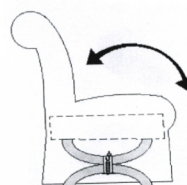
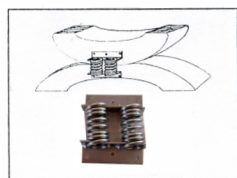
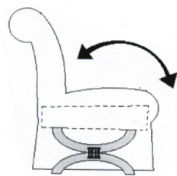

MODELO:	CONJUNTO BALANCÍN 2 MUELLES	UNDS.
COD.	DESCRIPCIÓN	
120151	Conjunto Balancín Muelles $\varnothing$ 5 x 2	100
120171	Conjunto Balancín Muelles $\varnothing$ 6 x 2,5	100

MODELO:	MUELLE BALANCÍN INTERIOR	UNDS.
COD.	DESCRIPCIÓN	
123333	Muelle Balancín $\varnothing$ 4,5 x 23 x 12 + Ga.	100
123354	Muelle Balancín $\varnothing$ 4,5 x 25 x 14 + Ga.	100

## Sofá Nido

MODELO:	PAR BISAGRA SOFÁ NIDO N.	UNDS.
COD.	DESCRIPCIÓN	X PALET
450002	Par Bisagra Sofá Nido N.	15 / 375

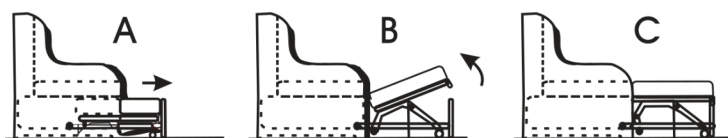



## Semi Cuña

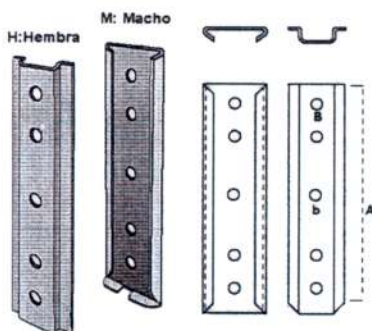

MODELO: SEMI CUÑAS DESMONTABLES			UNDS.
COD.	DESCRIPCIÓN	A	
115201	Semi Cuña MACHO 88 mm. CIN	88 mm.	400
115211	Semi Cuña HEMBRA 88 mm. CIN	88 mm.	400
115301	Semi Cuña MACHO 125 mm. CIN	125 mm.	400
115311	Semi Cuña HEMBRA 125 mm. CIN	125 mm.	400
115401	Semi Cuña MACHO 150 mm. CIN	150 mm.	400
115411	Semi Cuña HEMBRA 150 mm. CIN	150 mm.	400

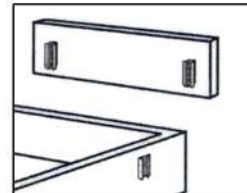

## Cuña

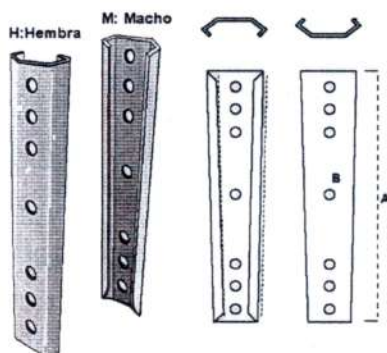

MODELO: CUÑAS DESMONTABLES			UNDS.
COD.	DESCRIPCIÓN	A	
115801	Cuña MACHO 150 mm. CIN	150 mm.	240
115811	Cuña HEMBRA 150 mm. CIN	150 mm.	240

## Unión Rinconeras

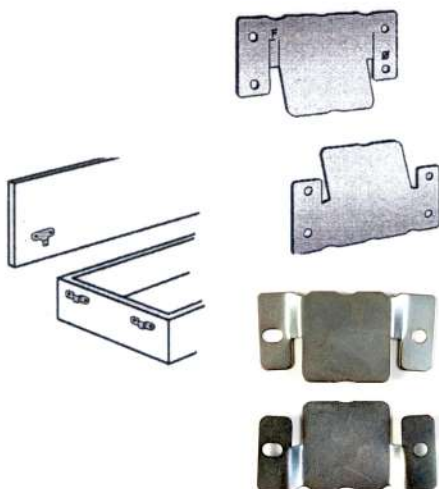

MODELO: UNIÓN RINCONERAS		UNDS. x PALET
COD.	DESCRIPCIÓN	
115102	Unión Rinconeras con 4 taladros CIN	500 / 10.000

MODELO: UNIÓN RINCONERAS		UNDS. x PALET
COD.	DESCRIPCIÓN	
115106	Unión Rinconeras con 2 taladros CIN	500 / 10.000

## Juego Enganche Bancada con Tornillo CIN

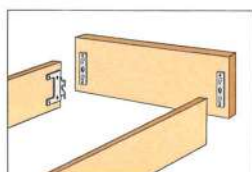
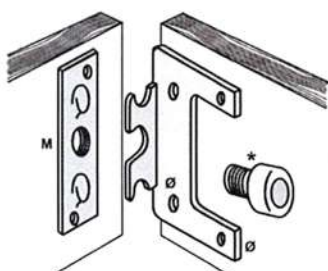

MODELO: JUEGO ENGANCHES		UNDS.
COD.	DESCRIPCIÓN	
	Juego Enganches Bancada + Tornillo CIN.	800



MODELO: ESCUADRA SOPORTE SOMIER CINCADA		UNDS.
COD.	DESCRIPCIÓN	X PALET
117852	Escuadra Soporte Somier CIN.	800 / 12800



Incorrecto



CORRECTO



MODELO: MUELLES COMPÁS		UNDS.
COD.	DESCRIPCIÓN	X PALET
123020	Muelle $\varnothing$ 2,7 x 17 x 79 + G Ext. Cin.	200 / 4000
123025	Muelle $\varnothing$ 2,7 x 15,8 x 79 + G Ext. Cin.	200 / 4000

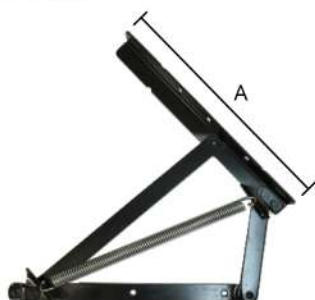

MODELO: COMPÁS DE MUELLE PINTADO NEGRO		ANCHO	UNDS.
COD.	DESCRIPCIÓN	A	X PALET
235027	Par Compás Muelles Std. Negro	330 mm.	15 / 500



MODELO: COMPÁS DE MUELLE PINTADO NEGRO		ANCHO	UNDS.
COD.	DESCRIPCIÓN	A	X PALET
235026	Par Compás Muelles T2DC. Negro	330 mm.	15 / 500

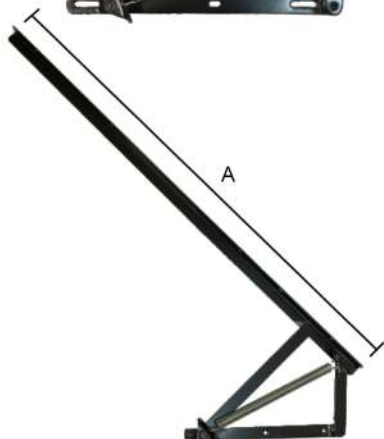

MODELO: COMPÁS DE MUELLE PINTADO NEGRO		ANCHO	UNDS.
COD.	DESCRIPCIÓN	A	X PALET
235138	Par Compás Muelles Std. 1150 Negro	1150 mm.	15 / 500

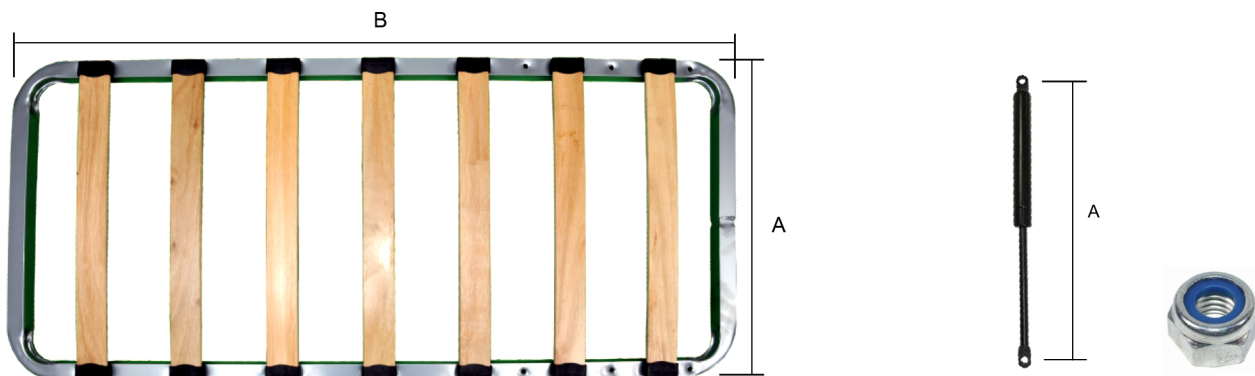

MODELO: SOMIER CHAÏSSE - LONGUE CON LAMAS DE MADERA		( mm. )		UNDS. x PALET
COD.	DESCRIPCIÓN	A	B	
227030	Somier 7 L. de 700 x 1300 mm.	700	1300	50
225525	Somier 7 L. de 550 x 1250 mm.	550	1250	50
227525	Somier 7 L. de 750 x 1250 mm.	750	1250	50
Consultar otras medidas				

MODELO: CILINDRO GAS COMPÁS		A	UNDS. X PALET
COD.	DESCRIPCIÓN		
174405	Cilindro de Gas 340 mm. de 350 N.	340 mm.	100 / 2000
Consultar otras potencias			
394002	Tuerca Autoblocante - M. 8 - Cin.		500 / 4000



MODELO: COMPÁS DE GAS PINTADO NEGRO		ANCHO A	UNDS. X PALET
COD.	DESCRIPCIÓN		
245023	Par Compás de Gas DC - COLIS 23 Negro	330 mm.	10 / 500



MODELO: COMPÁS DE GAS PINTADO NEGRO		ANCHO A	UNDS. X PALET
COD.	DESCRIPCIÓN		
2481851	Par Compás de Gas M2030 SOM2. Negro	430 mm.	10 / 500

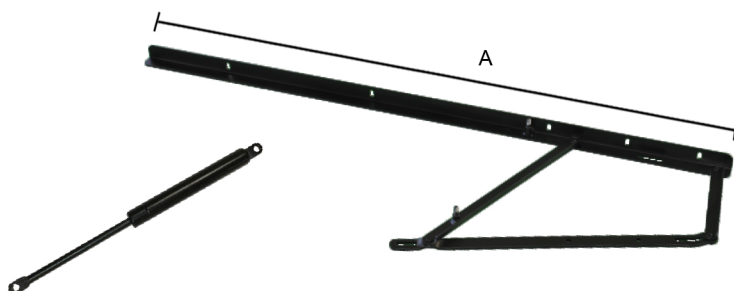

MODELO: COMPÁS DE GAS PINTADO NEGRO		ANCHO A	UNDS. X PALET
COD.	DESCRIPCIÓN		
2451351	Par Compás de Gas M2010. 1150. Negro	1150 mm.	10 / 500

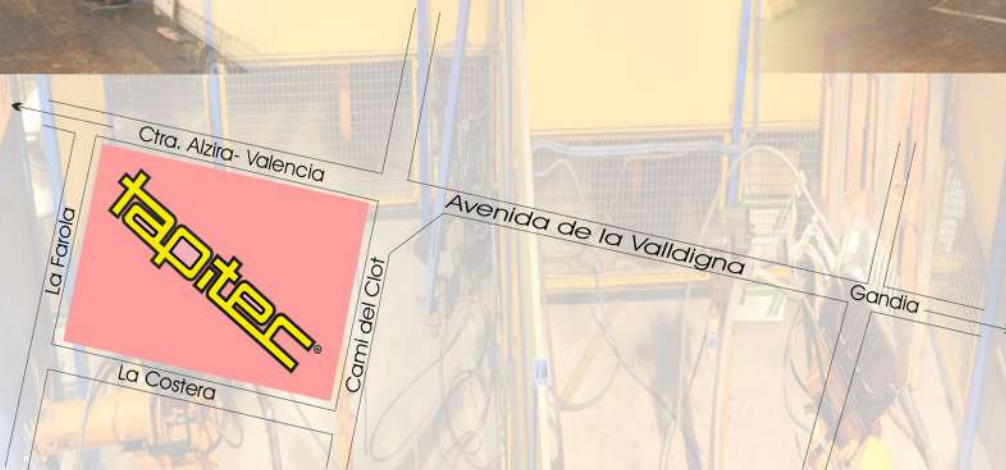

\* **BISAGRAS COMPÁS CHAISSE LONGUE**

\* **ASIENTOS EXTRAIBLES**

\* **CABEZALES RECLINABLES**

\* **MECANISMOS SILLÓN RELAX**

\* **MECANISMOS SILLÓN RELAX  
MOTORIZADOS**

\* **BISAGRAS SOFÁS LIBRO**

\* **AUXILIARES**

- Uniones Rinconeras
- Asiento Tapicería
- Cabezal Basculante
- Semi-Cuña
- Tornillería
- Patas Plástico
- Pies Giratorios
- Balancines

**tapitec**<sup>®</sup>  
TÉCNICAS DE TAPICERÍA TAPITEC, S.L.

**Modelos 2020**

En todos nuestros fabricados cuyos componentes están pintados y/o cincados, se han tomado las medidas anti-corrosión para el uso en interiores, advirtiendo que la utilización de disolventes y/o limpiadores fuertes pueden dañar el acabado de los mismos. Para dar mayor durabilidad a nuestros productos sus componentes se pintan y/o cincan inmediatamente antes de proceder a su ensamblaje. El fabricante se reserva el derecho de efectuar las modificaciones de diseño y características de los artículos que estime convenientes sin previa comunicación al respecto.